



# FENNOSTEEL OY

**OHUTSEINÄISET TERÄSPUTKET  
HUIPPUPINNOITTEILLA**

**THIN WALL STEEL TUBES WITH STATE OF THE ART  
METALLIC COATINGS**

FI-EN C 01/2017

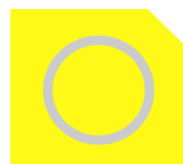



*FennoSteel Oy on suomalainen ohutseinäputkien valmistaja vaativiin käyttökohteisiin. Palvelemme komponentti-, ajoneuvo- ja konevalmistajia sekä teräsrakentamisen ammattilaisia huipputuotteilla ja joustavalla palvelulla. Meidän kauttamme saat putket aina alan viimeisimmillä pinnoitevaihtoehdoilla.*

*FennoSteel Oy is a Finnish company specialized in manufacturing of thin wall tubes for demanding applications. Our customers are professionals in component, vehicle and equipment manufacturing and construction business. FennoSteel differentiates from competition with state of the art products and flexible service. Our product range offers always the most modern metallic coatings.*

## PUTKIMATERIAALIT - TUBE MATERIALS

Yksi suurimmista vahvuusistamme on joustavuus materiaalivaihtojen suhteen. Voit valita perusteräksen ja pinnoitteen seuraavista laaduista:

One of our strengths is extreme flexibility in base material and surface coating combination. You can select from the following grades:

	Ei pinnoitusta No coating	Kuumasinkitys Hot dip Zink galvanized	Kuuma-alumiinointi Hot-dip Aluminium galvanized	Kuuma-alusinkitys Hot dip Aluminium-Zink galvanized	Kuumakäsittely magnesiumseosteisellä pinnoitteella Hot-dip Zink-Aluminium-Magnesium galvanized
Pehmeät muokkaus- ja vetolaadut Soft cold forming / drawing steels	1-4 mm	1-3 mm	1-2 mm	1-2 mm	1-2 mm
Rakenneteräkset Structural steels	1-4 mm	1-3 mm	1-2 mm	1-2 mm	1-2 mm
Korkealujuusteräkset High strength steels	1-3 mm	1-3 mm	1-2 mm	1-2 mm	1-2 mm

Huomioithan että valmistamme putkia myös asiakaskohtaisista erityislaaduista ja pinnoitteista. Please note that we produce tubes as well of customer specific special grades and coatings.

## ERIKOISPROFIILIT - SPECIAL PROFILES

### ASIAKASKOHTAISET KOOT JA MUODOT - CUSTOMER SPECIFIC SIZES AND SHAPES

Tuotantomme on erittäin joustava ja mahdollistaa asiakkaan erikoisprofiilien valmistamisen sekä oman merkinnän tuotteisiin. Tätä erikoispalvelua kannattaa kysyä myynnistämme.

Our production is extremely flexible and enables us to manufacture customer specific profiles with their own identification marking. Please consult our sales team for this special service.

### MÄÄRÄMITTAPALVELU - CUT-TO-SIZE SERVICE

Tuotantolinjamme sahauspalvelu mahdollistaa tilauskohtaiset putkipituudet. Erikoispalveluna sahaamme putket tarkasti lopulliseen käyttökohteen mittaan.

Our cutting service fine cuts customer specific tube lengths ready for your application.





PITUUS - LENGHT	ALATOLERANSSI - LOWER TOLERANCE	YLÄTOLERANSSI - UPPER TOLERANCE
2000 mm - 10000 mm	-0,0 mm	+3,0 mm
erityisvaateet - special requests	-0,25 mm	+0,25 mm

	KOKO - SIZE	ALATOLERANSSI - LOWER TOLERANCE	YLÄTOLERANSSI - UPPER TOLERANCE
<b>PYÖREÄT - ROUNDS</b>	D19,0 mm - 28,0 mm	-0,10 mm	+0,10 mm
	D32,0 mm - 63,5 mm	-0,20 mm	+0,20 mm
	D70,0 mm - 89,0 mm	-0,25 mm	+0,25 mm
<b>NELIÖT - SQUARES</b>	20 x 20 mm - 40 x 40 mm	-0,20 mm	+0,20 mm
	50 x 50 mm - 70 x 70 mm	-0,25 mm	+0,25 mm
<b>RECTANGLES</b>	25 x 15 mm - 70 x 40 mm	-0,20 mm	+0,20 mm
	80 x 30 mm - 100 x 40 mm	-0,25 mm	+0,25 mm
<b>OVAALIT - OVALS</b>	25 x 15 mm - 70 x 9 mm	-0,20 mm	+0,20 mm
<b>ELLIPSIT - ELLIPSES</b>	50 x 25 mm	-0,20 mm	+0,20 mm

Halkaisija ja ympyrämäisyys tarkistetaan työntömitalla vähintään 100mm etäisyydeltä putken päästä.

Diameter and roundness are measured with vernier caliber keeping minimum 100 mm distance from the end of the tube.

Putkien suoruus tarkastetaan visuaalisesti kahta putkea toisiinsa verraten. Hitsausseaman ulkonäön naarmujen, lommojen, jäysteiden ja sauman ruiskutuksen osalta tarkistetaan visuaalisesti.

Tube straightness is checked by comparing two tubes to each other. Welding seam quality, (no burr, scratches or dents allowed) and seam coating with anti-corrosion agent is checked as well visually.

Sauman ja perusmateriaalin kestävyys tarkistetaan pullistustestillä huomioiden raaka-ainekohtaiset ominaisuudet. Testinaikaista sauman repeämää ei sallita.

Seam weld strength is experimented with expansion test and qualification criterion are defined based on raw material properties. No seam damage allowed.

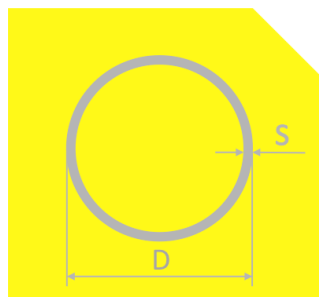

TUOTEKODI - PRODUCT CODE

XX19100

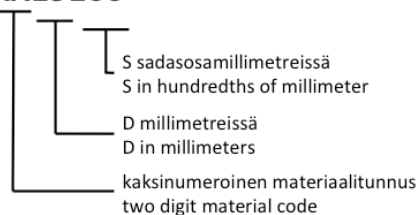

Halkaisija D (mm) Diameter D (mm)	S (mm)	kg/m	Pituus Length	Tuotekoodi Product code	Kpl/nippu Pcs/bunch	m/nippu m/bunch	kg/nippu kg/bunch
19	1	0,44	6 m	XX19100	169	1014 m	446 kg
19	1,25	0,55	6 m	XX19125	169	1014 m	558 kg
19	1,5	0,65	6 m	XX19150	169	1014 m	659 kg
19	2	0,84	6 m	XX19200	169	1014 m	852 kg
22	1	0,52	6 m	XX22100	127	762 m	396 kg
22	1,25	0,64	6 m	XX22125	127	762 m	488 kg
22	1,5	0,76	6 m	XX22150	127	762 m	579 kg
22	2	0,99	6 m	XX22200	127	762 m	754 kg
25	1	0,59	6 m	XX25100	91	546 m	322 kg
25	1,25	0,73	6 m	XX25125	91	546 m	399 kg
25	1,5	0,87	6 m	XX25150	91	546 m	475 kg
25	1,65	0,96	6 m	XX25165	91	546 m	524 kg
25	2	1,13	6 m	XX25200	91	546 m	617 kg
28	1	0,67	6 m	XX28100	91	546 m	366 kg
28	1,25	0,82	6 m	XX28125	91	546 m	448 kg
28	1,5	0,98	6 m	XX28150	91	546 m	535 kg
28	2	1,28	6 m	XX28200	91	546 m	699 kg
32	1	0,76	6 m	XX32100	127	762 m	579 kg
32	1,25	0,95	6 m	XX32125	127	762 m	724 kg
32	1,5	1,13	6 m	XX32150	127	762 m	861 kg
32	2	1,48	6 m	XX32200	127	762 m	1128 kg
32	3	2,15	6 m	XX32300	127	762 m	1638 kg
32	4	3	6 m	XX32400	127	762 m	2286 kg
35	1	0,84	6 m	XX35100	127	762 m	640 kg
35	1,25	1,04	6 m	XX35125	127	762 m	792 kg
35	1,5	1,24	6 m	XX35150	127	762 m	945 kg
35	2	1,63	6 m	XX35200	127	762 m	1242 kg
35	3	2,37	6 m	XX35300	127	762 m	1806 kg
35	4	3,3	6 m	XX35400	127	762 m	2515 kg
38	1	0,91	6 m	XX38100	91	546 m	497 kg
38	1,25	1,13	6 m	XX38125	91	546 m	617 kg
38	1,5	1,35	6 m	XX38150	91	546 m	737 kg
38	2	1,78	6 m	XX38200	91	546 m	972 kg
38	3	2,59	6 m	XX38300	91	546 m	1414 kg
38	4	3,57	6 m	XX38400	91	546 m	1949 kg
40	1	0,96	6 m	XX40100	91	546 m	524 kg
40	1,25	1,2	6 m	XX40125	91	546 m	655 kg
40	1,5	1,42	6 m	XX40150	91	546 m	775 kg
40	2	1,87	6 m	XX40200	91	546 m	1021 kg
40	3	2,74	6 m	XX40300	91	546 m	1496 kg
40	4	3,77	6 m	XX40400	91	546 m	2058 kg

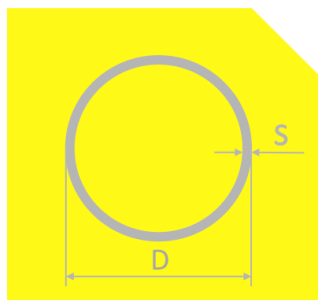

TUOTEKODI - PRODUCT CODE

XX42100

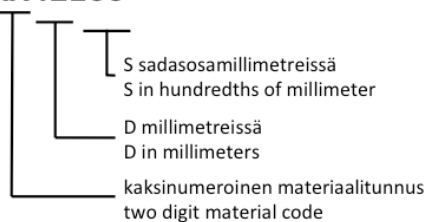

Halkaisija D (mm) Diameter D (mm)	S (mm)	kg/m	Pituus Length	Tuotekoodi Product code	Kpl/nippu Pcs/bunch	m/nippu m/bunch	kg/nippu kg/bunch
42	1	1,01	6 m	XX42100	61	366 m	370 kg
42	1,25	1,26	6 m	XX42125	61	366 m	461 kg
42	1,5	1,5	6 m	XX42150	61	366 m	549 kg
42	2	1,98	6 m	XX42200	61	366 m	725 kg
42	3	2,89	6 m	XX42300	61	366 m	1058 kg
42	4	3,96	6 m	XX42400	61	366 m	1449 kg
44	1	1,06	6 m	XX44100	61	366 m	388 kg
44	1,25	1,32	6 m	XX44125	61	366 m	483 kg
44	1,5	1,58	6 m	XX44150	61	366 m	578 kg
44	2	2,08	6 m	XX44200	61	366 m	761 kg
44	3	3,03	6 m	XX44300	61	366 m	1109 kg
44	4	4,16	6 m	XX44400	61	366 m	1523 kg
45	1	1,09	6 m	XX45100	61	366 m	399 kg
45	1,25	1,35	6 m	XX45125	61	366 m	494 kg
45	1,5	1,61	6 m	XX45150	61	366 m	589 kg
45	2	2,12	6 m	XX45200	61	366 m	776 kg
48	1	1,16	6 m	XX48100	61	366 m	425 kg
48	1,25	1,44	6 m	XX48125	61	366 m	527 kg
48	1,5	1,72	6 m	XX48150	61	366 m	630 kg
48	2	2,27	6 m	XX48200	61	366 m	831 kg
48	3	3,33	6 m	XX48300	61	366 m	1219 kg
48	4	4,54	6 m	XX48400	61	366 m	1662 kg
50	1	1,21	6 m	XX50100	61	366 m	443 kg
50	1,25	1,51	6 m	XX50125	61	366 m	553 kg
50	1,5	1,8	6 m	XX50150	61	366 m	659 kg
50	2	2,37	6 m	XX50200	61	366 m	867 kg
50,8	1	1,23	6 m	XX508100	61	366 m	450 kg
50,8	1,25	1,53	6 m	XX508125	61	366 m	560 kg
50,8	1,5	1,82	6 m	XX508150	61	366 m	666 kg
50,8	2	2,41	6 m	XX508200	61	366 m	882 kg
50,8	2,5	2,98	6 m	XX508250	61	366 m	1091 kg
50,8	3	3,54	6 m	XX508300	61	366 m	1296 kg
50,8	4	4,82	6 m	XX508400	61	366 m	1764 kg
54	1,25	1,63	6 m	XX54125	37	222 m	362 kg
54	1,5	1,96	6 m	XX54150	37	222 m	435 kg
54	2	2,57	6 m	XX54200	37	222 m	571 kg
55	1,25	1,68	6 m	XX55125	37	222 m	373 kg
55	1,5	1,98	6 m	XX55150	37	222 m	440 kg
55	2	2,62	6 m	XX55200	37	222 m	582 kg
55	3	3,94	6 m	XX55300	37	222 m	875 kg
55	4	5,22	6 m	XX55400	37	222 m	1159 kg

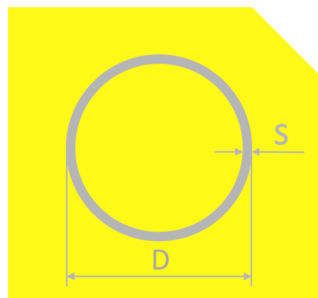

TUOTEKODI - PRODUCT CODE

XX57125

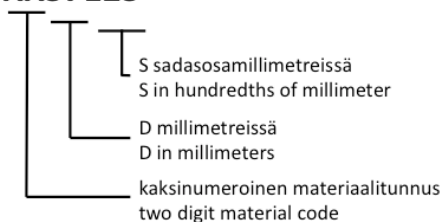

Halkaisija D (mm) Diameter D (mm)	S (mm)	kg/m	Pituus Length	Tuotekoodi Product code	Kpl/nippu Pcs/bunch	m/nippu m/bunch	kg/nippu kg/bunch
57	1,25	1,72	6 m	XX57125	37	222 m	382 kg
57	1,5	2,06	6 m	XX57150	37	222 m	457 kg
57	2	2,72	6 m	XX57200	37	222 m	604 kg
60	1,25	1,81	6 m	XX60125	37	222 m	402 kg
60	1,5	2,16	6 m	XX60150	37	222 m	480 kg
60	2	2,86	6 m	XX60200	37	222 m	635 kg
60	2,5	3,55	6 m	XX60250	37	222 m	788 kg
60	3	4,24	6 m	XX60300	37	222 m	941 kg
60	4	5,55	6 m	XX60400	37	222 m	1232 kg
63,5	1,25	1,94	6 m	XX635125	37	222 m	431 kg
63,5	1,5	2,3	6 m	XX635150	37	222 m	511 kg
63,5	2	3,04	6 m	XX635200	37	222 m	675 kg
63,5	2,5	3,76	6 m	XX635250	37	222 m	835 kg
63,5	3	4,48	6 m	XX635300	37	222 m	995 kg
63,5	4	6,04	6 m	XX635400	37	222 m	1341 kg
65	1,5	2,35	6 m	XX65150	19	114 m	268 kg
65	2	3,11	6 m	XX65200	19	114 m	355 kg
70	1,5	2,54	6 m	XX70150	19	114 m	290 kg
70	2	3,36	6 m	XX70200	19	114 m	383 kg
70	3	5,03	6 m	XX70300	19	114 m	573 kg
70	4	6,67	6 m	XX70400	19	114 m	760 kg
75	1,5	2,73	6 m	XX75150	19	114 m	311 kg
75	2	3,6	6 m	XX75200	19	114 m	410 kg
76	1,5	2,76	6 m	XX76150	19	114 m	315 kg
76	2	3,65	6 m	XX76200	19	114 m	416 kg
76	3	5,41	6 m	XX76300	19	114 m	617 kg
76	4	7,11	6 m	XX76400	19	114 m	811 kg
80	1,5	2,91	6 m	XX80150	19	114 m	332 kg
80	2	3,85	6 m	XX80200	19	114 m	439 kg
89	1,5	3,24	6 m	XX89150	19	114 m	369 kg
89	2	4,29	6 m	XX89200	19	114 m	489 kg
89	3	6,36	6 m	XX89300	19	114 m	725 kg
89	4	8,38	6 m	XX89400	19	114 m	955 kg

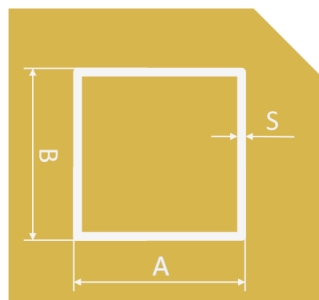

## TUOTEKODI - PRODUCT CODE

XX2020100

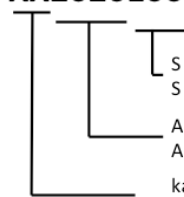

S sadasosamillitreissä  
S in hundredths of millimeter

A ja B millitreissä  
A and B in millimeters

kaksinumeroinen materiaalitunnus  
two digit material code

Mitat AxB Dimensions A x B	S (mm)	kg/m	Pituus Length	Tuotekoodi Product code	Kpl/nippu Pcs/bunch	m/nippu m/bunch	kg/nippu kg/bunch
20x20	1	0,59	6 m	XX2020100	200	1200 m	708 kg
20x20	1,25	0,73	6 m	XX2020125	200	1200 m	876 kg
20x20	1,5	0,87	6 m	XX2020150	200	1200 m	1044 kg
20x20	2	1,14	6 m	XX2020165	200	1200 m	1368 kg
25x25	1	0,76	6 m	XX2525100	170	1020 m	775 kg
25x25	1,25	0,95	6 m	XX2525125	170	1020 m	969 kg
25x25	1,5	1,13	6 m	XX2525150	170	1020 m	1153 kg
25x25	2	1,48	6 m	XX2525200	170	1020 m	1510 kg
30x30	1	0,91	6 m	XX3030100	112	672 m	612 kg
30x30	1,25	1,13	6 m	XX3030125	112	672 m	759 kg
30x30	1,5	1,35	6 m	XX3030150	112	672 m	907 kg
30x30	2	1,78	6 m	XX3030200	112	672 m	1196 kg
35x35	1	1,06	6 m	XX3535100	84	504 m	534 kg
35x35	1,25	1,31	6 m	XX3535125	84	504 m	660 kg
35x35	1,5	1,56	6 m	XX3535150	84	504 m	786 kg
35x35	2	2,08	6 m	XX3535200	84	504 m	1048 kg
35x35	3	3,11	6 m	XX3535300	84	504 m	1567 kg
40x40	1,25	1,53	6 m	XX4040125	50	300 m	459 kg
40x40	1,5	1,82	6 m	XX4040150	50	300 m	546 kg
40x40	2	2,41	6 m	XX4040200	50	300 m	723 kg
40x40	3	3,48	6 m	XX4040300	50	300 m	1044 kg
50x50	1,25	1,97	6 m	XX5050125	50	300 m	591 kg
50x50	1,5	2,30	6 m	XX5050150	50	300 m	690 kg
50x50	2	3,04	6 m	XX5050200	50	300 m	912 kg
50x50	3	4,48	6 m	XX5050300	50	300 m	1344 kg
60x60	1,5	2,76	6 m	XX6060150	30	180 m	497 kg
60x60	2	3,65	6 m	XX6060200	30	180 m	657 kg
60x60	3	5,41	6 m	XX6060300	30	180 m	974 kg
70x70	1,5	3,24	6 m	XX7070150	30	180 m	583 kg
70x70	2	4,29	6 m	XX7070200	30	180 m	772 kg
70x70	3	6,36	6 m	XX7070300	30	180 m	1145 kg

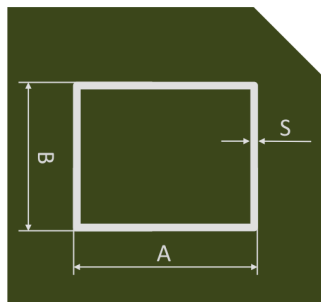

TUOTEKOODI - PRODUCT CODE

**XX2515100**

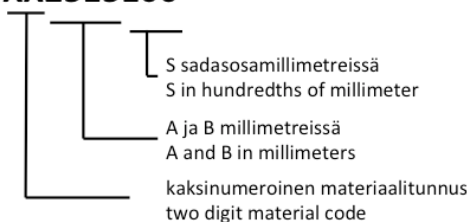

Mitat AxB Dimensions A x B	S (mm)	kg/m	Pituus Length	Tuotekoodi Product code	Kpl/nippu Pcs/bunch	m/nippu m/bunch	kg/nippu kg/bunch
25x15	1	0,59	6 m	XX2515100/SK	120	720 m	425 kg
25x15	1,25	0,73	6 m	XX2515125	120	720 m	526 kg
25x15	1,5	0,87	6 m	XX2515150	120	720 m	626 kg
25x15	2	1,14	6 m	XX2515200	120	720 m	821 kg
30x15	1	0,67	6 m	XX3015100			
30x15	1,25	0,82	6 m	XX3015125	200	1200 m	984 kg
30x15	1,5	0,99	6 m	XX3015150	200	1200 m	1188 kg
30x15	2	1,28	6 m	XX3015200	200	1200 m	1536 kg
30x20	1	0,75	6 m	XX3020100	140	840 m	630 kg
30x20	1,25	0,95	6 m	XX3020125	140	840 m	798 kg
30x20	1,5	1,13	6 m	XX3020150	140	840 m	949 kg
30x20	2	1,48	6 m	XX3020200	140	840 m	1243 kg
30x20	3	2,15	6 m	XX3020300	140	840 m	1806 kg
40x20	1	0,91	6 m	XX4020100	100	600 m	546 kg
40x20	1,25	1,13	6 m	XX4020125	100	600 m	678 kg
40x20	1,5	1,35	6 m	XX4020150	100	600 m	810 kg
40x20	2	1,78	6 m	XX4020200	100	600 m	1068 kg
40x20	3	3,11	6 m	XX4020300	100	600 m	1866 kg
40x30	1,25	1,32	6 m	XX4030125	80	480 m	634 kg
40x30	1,5	1,57	6 m	XX4030150	80	480 m	754 kg
40x30	2	2,07	6 m	XX4030200	80	480 m	994 kg
40x30	3	3,11	6 m	XX4030300	80	480 m	1493 kg
50x20	1,25	1,32	6 m	XX5020125	50	300 m	396 kg
50x20	1,5	1,57	6 m	XX5020150	50	300 m	471 kg
50x20	2	2,12	6 m	XX5020200	50	300 m	636 kg
50x20	3	3,11	6 m	XX5020300	50	300 m	933 kg
50x30	1,25	1,53	6 m	XX5030125	50	300 m	459 kg
50x30	1,5	1,82	6 m	XX5030150	50	300 m	546 kg
50x30	2	2,41	6 m	XX5030200	50	300 m	723 kg
50x30	3	3,48	6 m	XX5030300	50	300 m	1044 kg
60x20	1,25	1,53	6 m	XX6020125	50	300 m	459 kg
60x20	1,5	1,82	6 m	XX6020150	50	300 m	546 kg
60x20	2	2,41	6 m	XX6020200	50	300 m	723 kg
60x30	1,25	1,76	6 m	XX6030125	50	300 m	528 kg
60x30	1,5	2,09	6 m	XX6030150	50	300 m	627 kg
60x30	2	2,86	6 m	XX6030200	50	300 m	858 kg
60x30	2,5	3,42	6 m	XX6030250	50	300 m	1026 kg



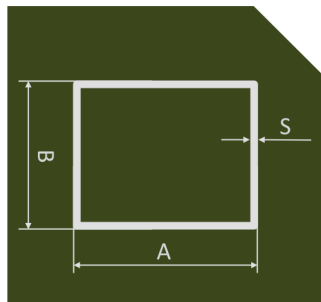

TUOTEKODI - PRODUCT CODE

XX6040125

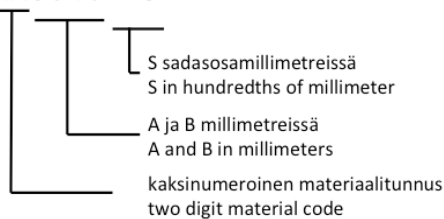

Mitat AxB Dimensions A x B	S (mm)	kg/m	Pituus Length	Tuotekoodi Product code	Kpl/nippu Pcs/bunch	m/nippu m/bunch	kg/nippu kg/bunch
60x40	1,25	1,94	6 m	XX6040125	48	288 m	559 kg
60x40	1,5	2,3	6 m	XX6040150	48	288 m	662 kg
60x40	2	3,04	6 m	XX6040200	48	288 m	876 kg
60x40	3	4,48	6 m	XX6040300	48	288 m	1290 kg
60x50	1,5	2,54	6 m	XX6050150	42	252 m	640 kg
60x50	2	3,36	6 m	XX6050200	42	252 m	847 kg
60x50	3	4,96	6 m	XX6050300	42	252 m	1250 kg
65x25	1,25	1,72	6 m	XX6525125	50	300 m	516 kg
65x25	1,5	2,06	6 m	XX6525150	50	300 m	618 kg
65x25	2	2,72	6 m	XX6525200	50	300 m	816 kg
70x11	1,5	1,82	6 m	XX7011150	120	720 m	1310 kg
70x11	2	2,41	6 m	XX7011200	120	720 m	1735 kg
70x25	1,25	1,81	6 m	XX7025125	48	288 m	521 kg
70x25	1,5	2,16	6 m	XX7025150	48	288 m	622 kg
70x25	2	2,86	6 m	XX7025200	48	288 m	824 kg
70x25	3	4,22	6 m	XX7025300	48	288 m	1215 kg
70x30	1,25	1,94	6 m	XX7030125	48	288 m	559 kg
70x30	1,5	2,29	6 m	XX7030150	48	288 m	660 kg
70x30	2	3,04	6 m	XX7030200	48	288 m	876 kg
70x30	3	4,48	6 m	XX7030300	48	288 m	1290 kg
70x40	1,5	2,54	6 m	XX7040150	48	288 m	732 kg
70x40	2	3,36	6 m	XX7040200	48	288 m	968 kg
70x40	3	4,96	6 m	XX7040300	48	288 m	1428 kg
80x30	1,5	2,54	6 m	XX8030150	50	300 m	762 kg
80x30	2	3,36	6 m	XX8030200	50	300 m	1008 kg
80x30	2,5	4,16	6 m	XX8030200	50	300 m	1248 kg
80x30	3	4,96	6 m	XX8030300	50	300 m	1488 kg
80x40	1,5	2,77	6 m	XX8040150	56	336 m	931 kg
80x40	2	3,65	6 m	XX8040200	56	336 m	1226 kg
80x40	3	5,4	6 m	XX8040300	56	336 m	1814 kg
100x40	1,5	3,24	6 m	XX10040150	40	240 m	778 kg
100x40	2	4,29	6 m	XX10040200	40	240 m	1030 kg
100x40	3	6,36	6 m	XX10040300	40	240 m	1526 kg

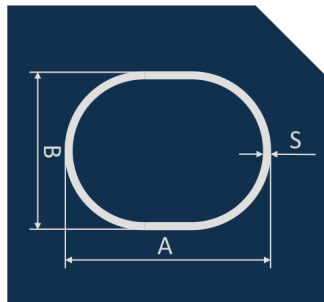

## TUOTEKODI - PRODUCT CODE

**XX2515100**

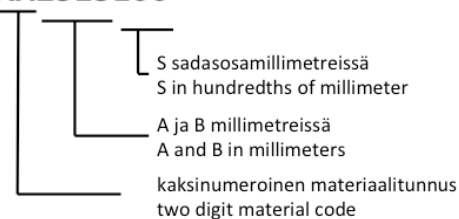

Mitat AxB Dimensions A x B	S (mm)	kg/m	Pituus Length	Tuotekoodi Product code	Kpl/nippu Pcs/bunch	m/nippu m/bunch	kg/nippu kg/bunch
25x15	1	0,52	6 m	XX2515100	100	600 m	312 kg
25x15	1,25	0,64	6 m	XX2515125	100	600 m	384 kg
25x15	1,5	0,76	6 m	XX2515150	100	600 m	456 kg
45x25	1	0,91	6 m	XX4525100	100	600 m	546 kg
45x25	1,25	1,13	6 m	XX4525125	100	600 m	678 kg
45x25	1,5	1,34	6 m	XX4525150	100	600 m	804 kg
45x25	2	1,72	6 m	XX4525200	100	600 m	1032 kg
45x25	3	2,59	6 m	XX4525300	100	600 m	1554 kg
51x30	1,5	1,32	6 m	XX5130150	50	300 m	396 kg
51x30	2	1,57	6 m	XX5130200	50	300 m	471 kg
51x30	3	2,07	6 m	XX5130300	50	300 m	621 kg
70x9	1,25	1,44	6 m	XX709125	120	720 m	1037 kg
70x9	1,5	1,72	6 m	XX709150	120	720 m	1238 kg
70x9	2	2,27	6 m	XX709200	120	720 m	1634 kg

# ELLIPSIPUTKET - ELLIPSE TUBES

## TUOTEKODI - PRODUCT CODE

**XX5025125**

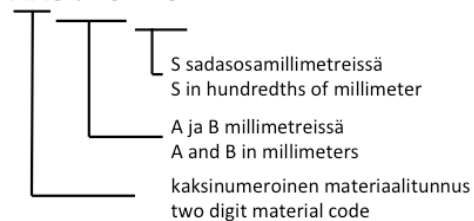
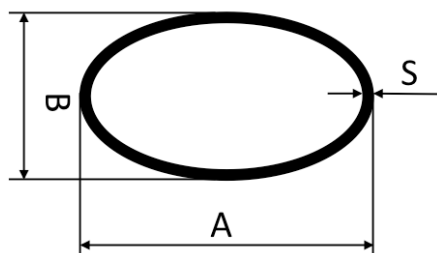

Mitat AxB Dimensions A x B	S (mm)	kg/m	Pituus Length	Tuotekoodi Product code	Kpl/nippu Pcs/bunch	m/nippu m/bunch	kg/nippu kg/bunch
50x25	1,25	1,2	6 m	XX5025125	91	546 m	655 kg
50x25	1,5	1,42	6 m	XX5025150	91	546 m	775 kg
50x25	2	1,87	6 m	XX5025200	91	546 m	1021 kg



**FENNOSTEEL OY**

Fennokatu 1, FI 39700 Parkano

tel. +358 3 441 00, fax +358 3 441 0250

fenno@fennosteel.com - [www.fennosteel.com](http://www.fennosteel.com)